



**Bedienungsanleitung  
Schlagschrauber,  
extra kurz**



**9012 M-1**



**Application Note  
Impact Wrench,  
extra short**

**Notice d'utilisation  
Clé à chocs,  
extra-courte**

**Toepassingsaanwijzing  
Slagmoersleutel,  
extra kort**















**Käyttöohje  
mutterinväännin,  
lyhyt**



|  | <i>de</i>   | <i>en</i>   | <i>fr</i>  | <i>nl</i>  | <i>fi</i>   |
|--|---|---|--|--|---|
|  | Ultra kompakte Bauweise optimiert für Arbeiten in beengten Räumen                             | <i>Ultra-compact design optimised for work in tight spaces</i>                        | <i>Exécution ultra-compacte optimisée aux travaux dans les endroits étroits</i>                            | <i>Ultra-compacte uitvoering geoptimaliseerd voor werken in kleine ruimten</i>                                 | <i>Erittäin kompakti rakenne työskentelyyn ahtaissa tiloissa</i>              |
|  | Beachten Sie unbedingt die beiliegenden Sicherheitsvorschriften für HAZET-Pneumatikwerkzeuge! | <i>Please observe the enclosed safety instructions for the HAZET pneumatic tools!</i> | <i>Veuillez respecter impérativement les consignes de sécurité pour les outils pneumatiques de HAZET !</i> | <i>Neem per se de bijgevoegde veiligheidsvoorschriften in acht voor pneumatische gereedschappen van HAZET!</i> | <i>Noudata HAZET-paineilmatyökalujen oheisia turvallisuusmääräyksiä!</i>      |
|  | Empf. Drehmoment  | <i>Recommended torque</i>   | <i>Couple recommandé</i>   | <i>Aanbevolen moment</i>   | <i>Suos. vääntömomentti</i>   |
|  | Max. Drehmoment   | <i>Max. torque</i>  | <i>Couple max.</i>   | <i>Maximaal moment</i>   | <i>Vääntömomentti maks.</i>   |
|  | Max. Lösemoment   | <i>Max. loosening torque</i>  | <i>Couple de desserrage max.</i>   | <i>Maximaal los moment</i>   | <i>Irrotusmomentti maks.</i>  |
|  | Max. Drehzahl/min.  | <i>Max. revolutions per minute</i>  | <i>Vitesse à vide max. / min.</i>  | <i>TPM max.</i>  | <i>Maks. pyörimisnopeus/min.</i>  |
|  | Luftbedarf  | <i>Air consumption</i>  | <i>Consommation d'air</i>  | <i>Lucht-verbruik</i>  | <i>Ilmantarve</i>   |
|  | Betriebsdruck   | <i>Working pressure</i>   | <i>Pression de service</i>   | <i>Werkdruk</i>  | <i>Käyttöpaine</i>  |
|  | Pneumatischer Schlagschrauber, Kupplungsstecker Nennweite 7,2 * mit Aufkängehaken             | <i>Pneumatic Impact Wrench, Coupler plug, nominal size 7.2 * with suspension hook</i> | <i>Clé à chocs pneumatique, Raccord de taille nominale 7.2 * avec crochet de suspension</i>                | <i>Pneumatische slagschroevendraaier, verbindingsstekker, nominale breedte 7,2 * Hook</i>                      | <i>Paineilmamutterinväännin, liitin nimelliskoko 7,2 * ripustuskoukuineen</i> |

Ursprungssprache deutsch – original language: German – Langue d'origine: allemand  
Oorspronkelijke taal Duits - Alkuperäinen kieli saksa

Technische Daten / Technical data / Informations techniques  
 Technische gegevens / Tekniset tiedot:

|   |   |   |
|---|---|---|
|    |   | M16   |
|    | m/s <sup>2</sup>  | 13.49   |
|    | dB(A)   | Lp W<br>103,2   |
|   |   | Lp A<br>92.2  |
|    | bar   | 6.3   |
|    | l/min.  | 127,4   |
|    | Ø mm  | 10  |
|    | kg  | 1.27  |
|   | 1/min   | 8800  |
|  | Nm  | 1200  |
|  | Nm  | 678   |
|  | Nm  | 610   |
|   | Ø mm  | 12,91 <sup>(1/4)</sup><br> |
|  | mm  | 12 <sup>5</sup> 1/2   |
| <b>HAZET</b><br>No.   |  |   |
|   | <b>9012</b><br><b>M-1</b>   |   |

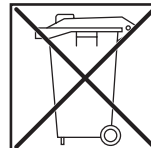
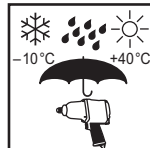
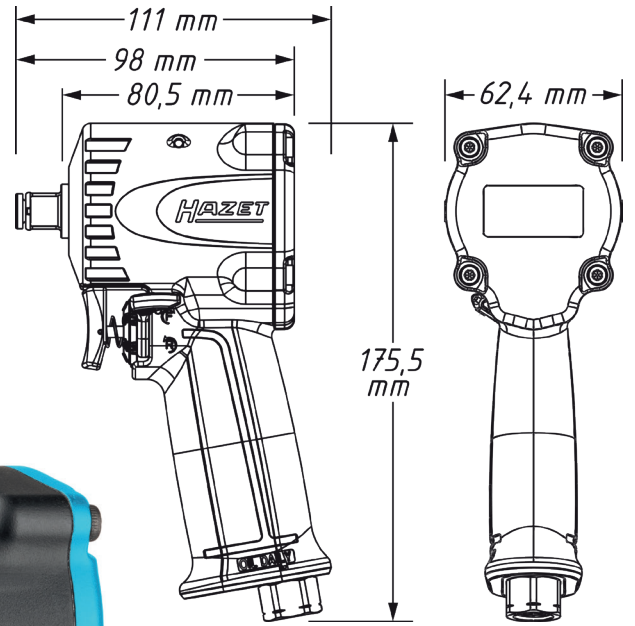

**HAZET-WERK** Hermann Zerver GmbH & Co. KG •  Güldenwerther Bahnhofstrasse 25-29 • 42857 Remscheid  
 ☒ 10 04 61 • 42804 Remscheid • GERMANY

☎ +49 (0) 21 91 / 7 92-0 • [www.hazet.de](http://www.hazet.de) • [e-mail info@hazet.de](mailto:info@hazet.de)